

# Panasonic EX

## **Cordless** Rotary Hammer

### Operating Instructions

Model No: EY6812

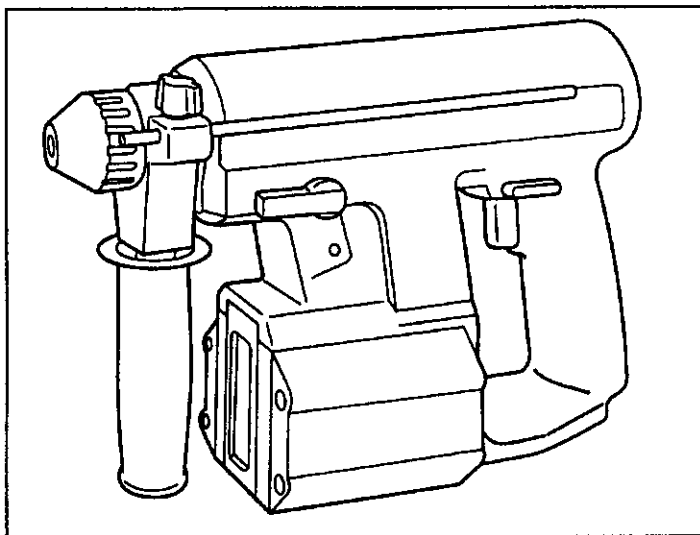

#### **IMPORTANT**

This manual contains safety information. Read manual completely before first using this product and save this manual for future use.

SAVE THESE INSTRUCTIONS

# GENERAL SAFETY RULES-FOR ALL BATTERY OPERATED TOOLS

## WARNING!

Read and understand all instructions.

- Failure to follow all instructions listed below, may result in electric shock, fire and/or serious personal injury.

## SAVE THESE INSTRUCTIONS

### Work Area

- 1) **Keep your work area clean and well lit.**  
Cluttered benches and dark areas invite accidents.
- 2) **Do not operate power tools in explosive atmospheres, such as in the presence of flammable liquids, gases, or dust.**  
Power tools create sparks which may ignite the dust or fumes.
- 3) **Keep bystanders, children, and visitors away while operating a power tool.**  
Distractions can cause you to lose control. Make sure that no one is beneath, or on the other side of the area when you are working.

### Electrical Safety

- 4) **A battery operated tool with integral batteries or a separate battery pack must be recharged only with the specified charger for the battery.**  
A charger that may be suitable for one type of battery may create a risk of fire when used with another battery.
- 5) **Use battery operated tool only with specifically designated battery pack.**  
Use of any other batteries may create a risk of fire.

### Personal Safety

- 6) **Stay alert, watch what you are doing, and use common sense when operating a power tool. Do not use tool while tired or under the influence of drugs, alcohol, or medication.**  
A moment of inattention while operating power tools may result in serious personal injury.
- 7) **Dress properly. Do not wear loose clothing or jewelry. Contain long hair.**  
**Keep your hair, clothing, and gloves away from moving parts.**  
Loose clothes, jewelry, or long hair can be caught in moving parts.
- 8) **Avoid accidental starting. Be sure switch is in the locked or off position before inserting battery pack.**  
Carrying tools with your finger on the switch or inserting the battery pack into a tool with the switch on invites accidents.
- 9) **Remove adjusting keys or wrenches before turning the tool on.**  
A wrench or a key that is left attached to a rotating part of the tool may result in personal injury.
- 10) **Do not overreach. Keep proper footing and balance at all times.**  
Proper footing and balance enable better control of the tool in unexpected situations.
- 11) **Use safety equipment. Always wear eye protection.**  
Dust mask, non-skid safety shoes, hard hat, or hearing protection must be used for appropriate conditions.

### Tool use and care

- 12) **Use clamps or other practical way to secure and support the work-piece to a stable platform.**  
Holding the work by hand or against your body is unstable and may lead to loss of control.

- 13) **Do not force tool. Use the correct tool for your application.**  
The correct tool will do the job better and safer at the rate for which it is designed.
- 14) **Do not use tool if switch does not turn it on or off.**  
A tool that cannot be controlled with the switch is dangerous and must be repaired.
- 15) **Disconnect battery pack from tool or place the switch in the locked or off position before making any adjustments, changing accessories, or storing the tool.**  
Such preventive safety measures reduce the risk of starting the tool accidentally.
- 16) **Store idle tools out of reach of children and other untrained persons.**  
Tools are dangerous in the hands of untrained users.
- 17) **When battery pack is not in use, keep it away from other metal objects like: paper clips, coins, keys, nails, screws, or other small metal objects that can make a connection from one terminal to another.**  
Shorting the battery terminals together may cause sparks, burns or a fire.
- 18) **Maintain tools with care. Keep cutting tools sharp and clean.**  
Properly maintained tools with sharp cutting edge are less likely to bind and are easier to control.
- 19) **Check for misalignment or binding of moving parts, breakage of parts, and any other condition that may affect the tool's operations. If damaged, have the tool serviced before using.**  
Many accidents are caused by poorly maintained tools.
- 20) **Use only accessories that are recommended by the manufacturer for your model.**  
Accessories that may be suitable for one tool may create a risk of injury when used on another tool.

## Service

- 21) **Tool service must be performed only by qualified repair personnel.**  
Service or maintenance performed by unqualified personnel may result in a risk of injury.
- 22) **When servicing a tool, use only identical replacement parts. Follow instructions in the Maintenance section of this manual.**  
Use of unauthorized parts or failure to follow Maintenance Instructions may create a risk of shock or injury.

## SPECIFIC SAFETY RULES

- 1) **Hold tool by insulated gripping surfaces when performing an operation where the cutting tool may contact hidden wiring.**  
Contact with a "live" wire will make exposed metal parts of the tool "live" and shock the operator.
- 2) **Wear ear protectors when using the tool for extended periods.**  
Prolonged exposure to high intensity noise can cause hearing loss.
- 3) **Be aware that this tool is always in an operating condition, it does not have to be plugged into an electrical outlet.**
- 4) **Do not operate the reversing lever when the main switch is on.**  
The battery will discharge rapidly and damage to the unit may occur.
- 5) **If the bit becomes jammed, immediately turn the main switch off to prevent an overload which can damage the battery pack or motor. Use reverse motion to loosen jammed bits.**
- 6) **When storing or carrying the tool, set the reversing lever to the center (switch lock) position.**
- 7) **Do not strain the tool by holding the speed control trigger halfway (speed control mode) so that the motor stops.**

- 8) During charging, the charger may become slightly warm. This is normal. Do not charge the battery for a long period.

# FOR BATTERY CHARGER & BATTERY PACK

Symbol	meaning
V	Volts
— — —	Direct Current
$n_0$	no load speed
.../min	revolutions or reciprocation per minutes
⌚	Forward Rotation
⌚	Reverse Rotation
⬆	Rotation with Hammering
⚡	Rotation only

- 1) **SAVE THESE INSTRUCTIONS** -This manual contains important safety and operating instructions for battery charger EY0214.
- 2) Before using battery charger, read all instructions and cautionary markings on (1) battery charger, (2) battery pack.
- 3) **CAUTION** -To reduce the risk of injury, charge only Battery Pack as shown below.  
EY9103, EY9101, EY9001, EY9006, EY9180, EY9080, EY9182, EY9086, EY9065, EY9106, EY9107, EY9136, EY9117, EY9230, EY9200, EY9108, EY9210  
Other types of batteries may burst causing personal injury and damage.
- 4) Do not expose charger to rain or snow.
- 5) To reduce risk of damaging the electric plug and cord, pull by plug rather than cord when disconnecting charger.
- 6) Make sure cord is located so that it will not be stepped on, tripped over, or otherwise subjected to damage or stress.

- 7) An extension cord should not be used unless absolutely necessary. Use of improper extension cord could result in a risk of fire and electric shock. If extension cord must be used, make sure:
- that pins on plug of extension cord are the same number, size and shape as those of plug on charger.
  - that extension cord is properly wired and in good electrical condition.
  - that wire size is large enough for ampere rating of charger as specified below.

RECOMMENDED MINIMUM AWG SIZE OF EXTENSION CORDS FOR BATTERY CHARGERS			
AC Input Rating, Amperes		AWG Size of Cord	
Equal to or greater than	But less than	Length of Cord, Feet	
		25	50 100 150
0	2	18	18 18 16

- Do not operate charger with damaged cord or plug—replace them immediately.
- Do not operate charger if it has received a sharp blow, been dropped, or otherwise damaged in any way; take it to a qualified serviceman.
- Do not disassemble charger; take it to a qualified serviceman when service or repair is required. Incorrect reassembly may result in a risk of electric shock or fire.
- To reduce the risk of electric shock, unplug charger from outlet before attempting any maintenance or cleaning.
- The charger and battery pack are specifically designed to work together. Do not attempt to charge any other cordless tool or battery pack with this charger.
- Do not attempt to charge the battery pack with any other charger.
- Do not attempt to disassemble the battery pack housing.

- Do not store the tool and battery pack in locations where the temperature may reach or exceed 122°F (50°C) (such a metal tool shed, or a car in the summer), which can lead to deterioration of the storage battery.
- Do not charge battery pack when the temperature is BELOW 32°F (0°C) or ABOVE 104°F (40°C). This is very important.
- Do not incinerate the battery pack. It can explode in a fire.
- Avoid dangerous environment. Do not use charger in damp or wet locations.
- The charger is designed to operate on standard household electrical power only. Do not attempt to use it on any other voltage!
- Do not abuse cord. Never carry charger by cord or yank it to disconnect from outlet. Keep cord away from heat, oil and sharp edges.
- Charge the battery pack in a well ventilated place, do not cover the charger and battery pack with a cloth, etc., while charging.
- Use of an attachment not recommended may result in a risk of fire, electric shock, or injury to persons.
- Do not short the battery pack. A battery short can cause a large current flow, over heating and burns.
- NOTE: If the supply cord of this appliance is damaged, it must only be replaced by a repair shop appointed by the manufacturer, because special purpose tools are required.
- TO REDUCE THE RISK OF ELECTRIC SHOCK, THIS APPLIANCE HAS A POLARIZED PLUG (ONE BLADE IS WIDER THAN THE OTHER). This plug will fit in a polarized outlet only one way. If the plug does not fit fully in the outlet, reverse the plug. If it still does not fit, contact a qualified electrician to install the proper outlet. Do not change the plug in any way.

# FUNCTIONAL DESCRIPTION

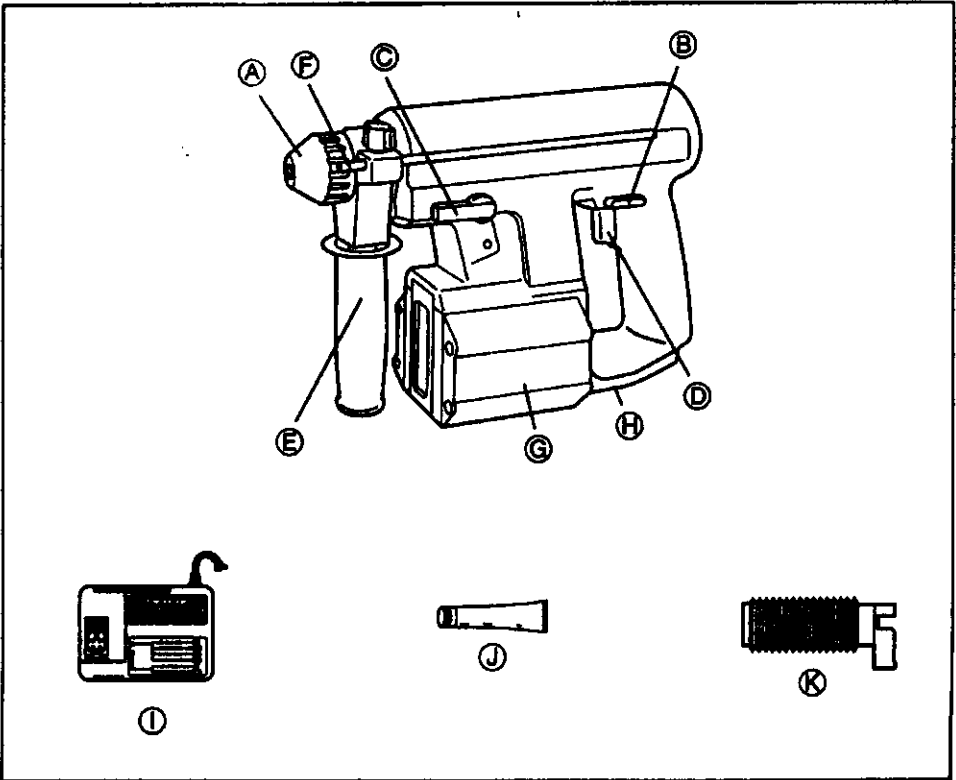

<b>(A)</b> Chuck	<b>(G)</b> Battery pack (EY9210)
<b>(B)</b> Reversing lever	<b>(H)</b> Released lever
<b>(C)</b> Hammering/drilling switching lever	<b>(I)</b> Battery charger (EY0214)
<b>(D)</b> Trigger	<b>(J)</b> Grease
<b>(E)</b> Auxiliary handle	<b>(K)</b> Dust collection cup
<b>(F)</b> Depth gauge	

# Operation

## Ⓐ Chuck

**Note:** Grease for bits

Grease the oval indentation on the bit with the supplied grease at least once a month.

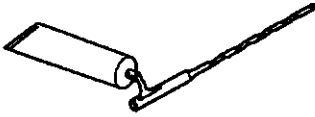

1. Align the oval uneven parts of the bit with the marks on the chuck as shown.
2. Turn the chuck counterclockwise. Insert the bit to the chuck as far as it will go.
3. Release the chuck when the bit is inserted completely. (The chuck goes back automatically and the bit is fixed.)
4. Make sure that the bit is fixed by pulling it.

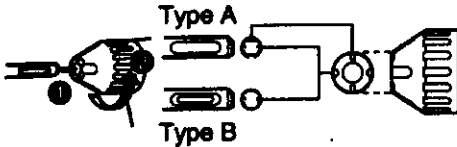

5. To remove the bit, turn the chuck counterclockwise, and pull the bit.

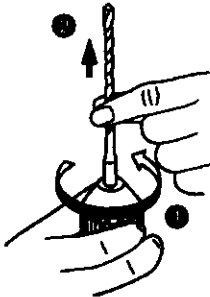

## Ⓑ Reversing lever

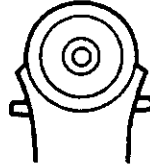
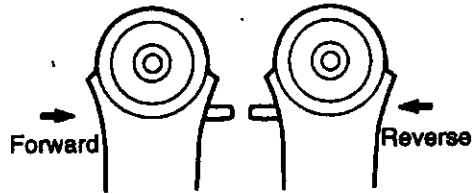

Be sure to set the switch in the center to lock it after use.

## Ⓒ Hammering/drilling switching lever

Selecting action mode

Position of switching lever	Action mode	Material
	Rotation with hammering	Concrete mortar, brick, etc.
	Rotation only	Tile, etc.

**Note:** Use drill mode when work with fragile materials like tile, etc.

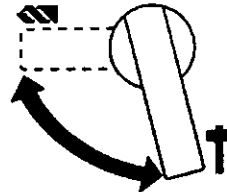

## Ⓓ Trigger

To set the center of a hole, pull the trigger slightly to start the drill rotating slowly.

### E Auxiliary handle

Place the auxiliary handle at your favorite position and tighten the handle securely.

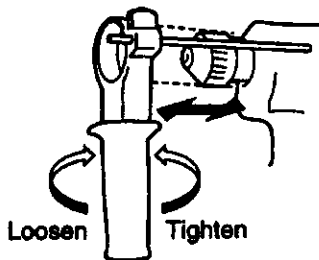

### F Depth gauge

Loosen the bolt and adjust the depth gauge at your favorite depth. After adjusting, tighten the bolt securely.

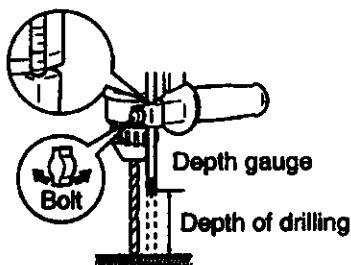

### G Battery Pack

**For Appropriate use of NI-MH Battery Pack EY9210**

- Charge the NI-MH battery fully before storage in order to ensure a longer service life.
- The ambient temperature range is between 0°C and 40°C. If the battery pack is used when the battery temperature is below 0°C, the tool may fail to function properly. In that case, charge the battery until charging is completed for appropriate functioning of the battery.

### Battery Pack Life

The rechargeable batteries have a limited life. If operation time becomes extremely short after recharging, replace the battery pack with a new one.

**Note:** • Use under extremely hot or cold conditions will reduce operating capacity per charge.

### H Release lever

- Battery pack Installation and Removal

-For removal-  
Pull the release lever to free the battery holder.

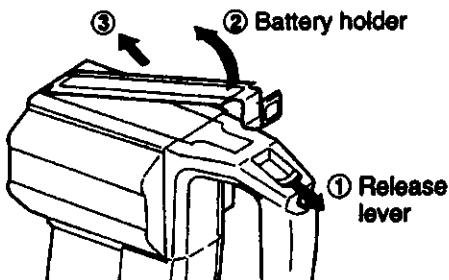

-For installation-  
Fit the battery holder unit it clicks in position.

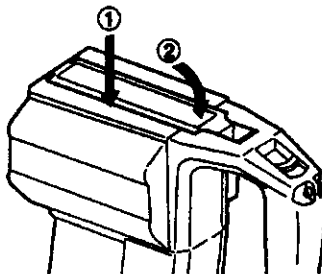

### I Battery charger

**Note:** Charge a new battery pack, or a battery pack that has not been used for a prolonged time, for about 24 hours to bring the battery up to full charge.



## EY0214

1. Plug the charger into an AC outlet.
2. Insert the battery pack firmly into the charger.

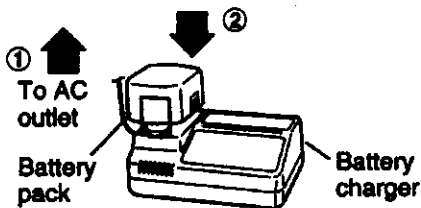

- When charging, cooling fan in the charger functions to cool down the battery pack, and the sound of fan can be heard. This is normal. If this sound cannot be heard, it is a malfunction. Stop charging immediately and consult an authorized dealer.
3. During charging, the charging lamp will light up. When the charge is completed, an internal electronic switch will automatically be triggered to prevent overcharging.
    - Charging will not occur if the battery pack is warm (for example, immediately after heavy-duty operation). The orange standby lamp will light up until the battery becomes cool. Charging will then begin automatically.
  4. When charging is completed, the charging lamp will start flashing quickly.
  5. When the battery pack has not been used for a long time, the charging lamp starts flashing slowly to indicate protective

charging. Protective charging takes longer to fully charge the battery pack, than the standard charging time. (Max. charging time is approx. 90 minutes.)

- If a fully charged battery pack is inserted into the charger again, the charging lamp may light up. After several minutes, the charging lamp may flash quickly to indicate the charging is completed.
6. If the charging lamp does not light immediately after the charger is plugged in, or if after the standard charging time the lamp does not go off, consult an authorized dealer.

**Note:** • When a cold battery (of about 5°C or less) is to be charged in a warm room, leave the battery in the room for at least one hour and charge it when it has warmed up to room temperature. (Failing to do so may result in less than a full charge.)

- Cool down the charger when charging more than two battery packs consecutively.
- Do not insert your fingers into contact hole, when holding charger or any other occasions.

**CAUTION:** • Do not use power source from an engine generator.  
• Do not cover vent holes on the charger and the battery pack.

## Lamp indications of the EY0214

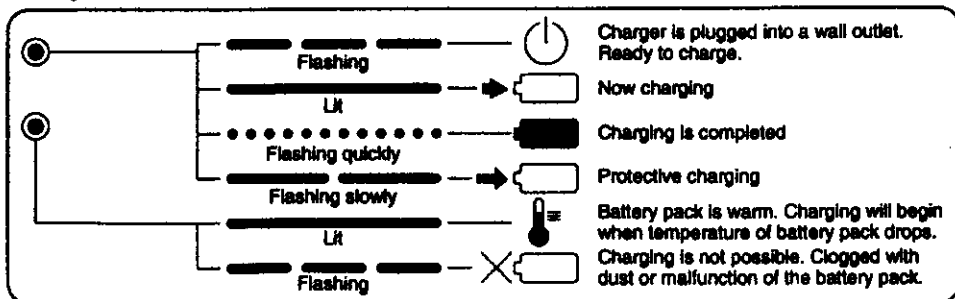

## ⓐ Grease

## Ⓚ Dust Collection Cup

\*Drills bits of which diameter is 20mm above cannot be installed.  
\*Do not use the tool for cutting other than concrete, mortar and other ceramic materials. If used for cutting metal materials, the dust collection cup may be damaged by the metal chip heat.

1. Install a drill bit.
2. Pass the drill bit through A and fix the cup at B by matching with the shape of the auxiliary handle.

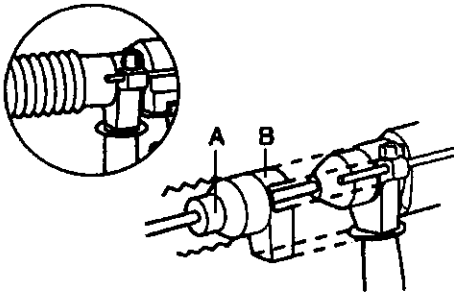

### Operation

Keep the dust collection cup in close contact with the wall surface during operation.

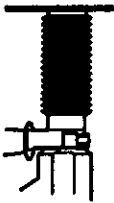

## Removal

Hold the root of the dust collection cup for removal.

Please remove after thoroughly getting rid of the dust in the dust collection cup.

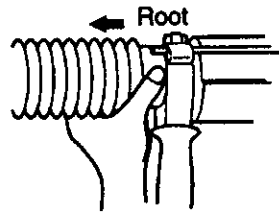

## Storage

Do not store the dust collection cup in squeeze state. If kept in squeezed state, permanent set may be caused to make returning to the original shape impossible.

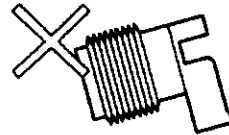

## Maintenance

Use only a dry, soft cloth for wiping the unit. Do not use a damp cloth, thinner, benzene, or other volatile solvents for cleaning.

# Specifications

## Main Unit (EY6812)

Maximum Drilling diameter	Concrete	20mm (25/32")
	Steel	13mm (33/64")
	Wood	27mm (1-1/16")
Motor voltage	DC Motor 24V	
Revolutions	0-950/min (rpm)	
Blows	0-4600/min (rpm)	
Weight (with battery pack)	3.68kg (8.1 lbs.)	
Dimensions (L x W x H)	291 x 199 x 68 mm (11-29/64" x 7-53/64" x 2-43/64")	

## Battery Pack (EY9210)

Storage Battery	Ni-MH Battery
Voltage	24V DC (1.2V x 20 cells)

## Battery Pack (EY0214)

Weight	0.97kg (2.14 lbs.)					
Charging time	Applicable Battery Pack					Standard charging time
	24V	15.6V	12V	9.6V	7.2V	
	---	---	EY9001 EY9006	EY9090 EY9088	EY9085	Approx. 20min.
	---	---	EY9101 EY9103	EY9180 EY9182	---	Approx. 25min.
	EY9117	EY9138	EY9105 EY9107 EY9108	---	---	Approx. 30min.
	EY9210	EY9230	EY9200	---	---	Approx. 45min.

**30-DAY QUALITY  
SATISFACTION GUARANTEE:**

If you are dissatisfied with any Panasonic Cordless Power Tool for any reason, simply return it to the place of purchase with a dated proof of purchase, in the original packaging, with all accessories, parts and instructions, within 30 days of the date of purchase, for a full refund, or call Panasonic at 201-392-6655. Abuse or misapplication of any power tool voids the guarantee.

**PANASONIC HOME & COMMERCIAL PRODUCTS COMPANY**

One Panasonic Way, Secaucus, New Jersey 07094